

Name \* Nom \* Nome \* Naaz \* Nazwa \* Jméno  
 Názov \* Név \* Denumire \* Isim \* Название

**INKA**

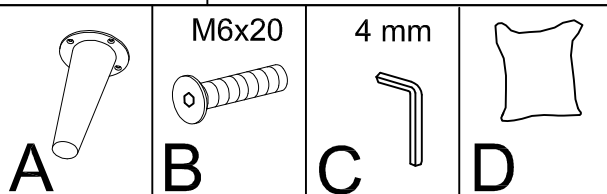

<b>1</b>	.....	.....	.....	.....	
<b>2</b>	.....	.....	.....	.....	
<b>3</b>	.....	.....	.....	.....	
<b>H</b>	.....	.....	.....	.....	

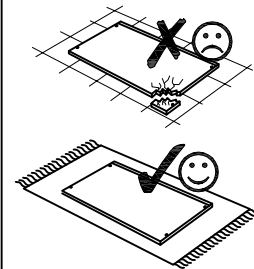
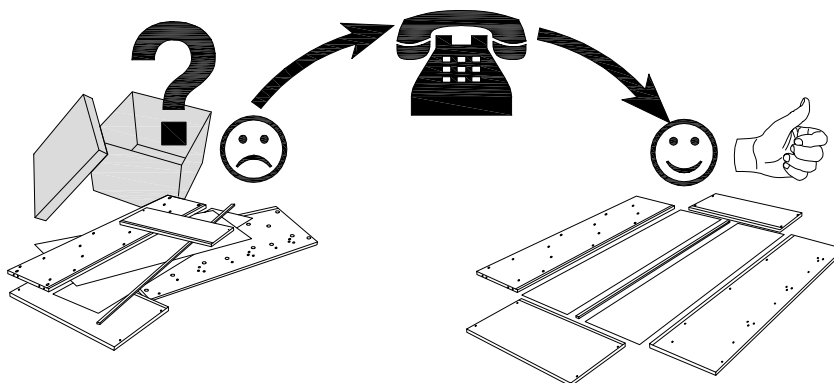
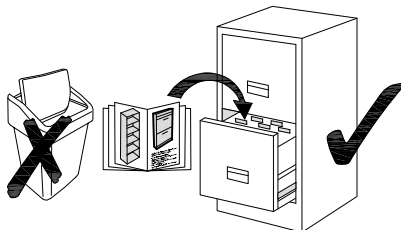
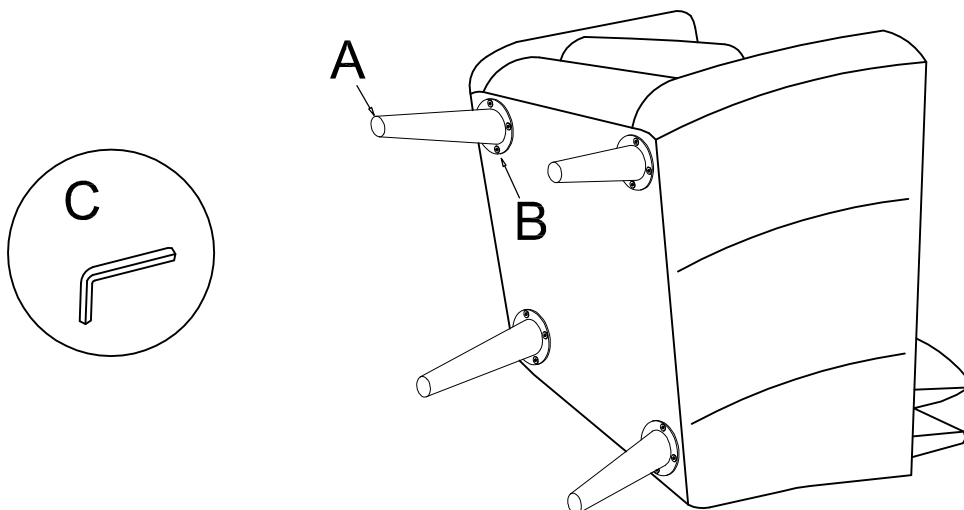

(D) Montageanleitung

(GB) Assembly instructions

(CZ) Montážní návod

(SK) Návod na montáž

(FR) Notice de montage

(IT) Istruzioni di montaggio

(HU) Szerelési útmutató

(RU) Instrucțiuni de montaj

(NL) Handleiding voor de montage

(PL) Instrukcja montażu



(TR) Montaj talimatı

(RU) Инструкция по монтажу



# INKA

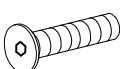
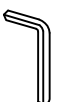

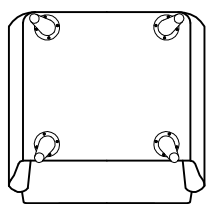
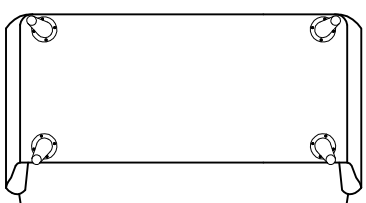
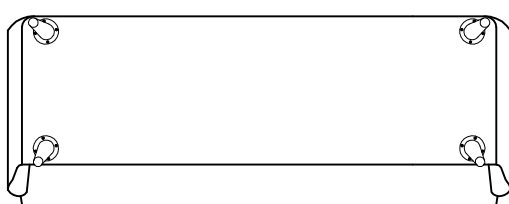
		 M6x20	 4 mm		
<b>1</b>	x4	x16	x1	x1	
<b>2</b>	x4	x16	x1	x2	
<b>3</b>	x4	x16	x1	x2	
<b>H</b>	x4	x16	x1		